

Rehateam s.r.l. - Vicolo Negrelli, 5 - 31038 Castagnole di Paese (TV) - Tel. +39 0422 484657/+39 0422 480387 - Fax +39 0422 484661/+39 0422 484684 - P.IVA IT 03182520266 - C.C.I.A.A. TV n.41690 Capitale Sociale I.V. Euro 100.000,00
 la società è soggetta ex art. 2497-bis C.C. al coordinamento e direzione della società "PERMOBIL ITALY SRL" iscritta al Registro Imprese Milano Monza Brianza Lodi 10246110968

Italia

Data Timbro ditta

Utilizzatore

Peso utilizzatore (kg)

Lingua manuale d'uso Responsabile

Carrozzina pieghevole basculante

Informazioni sull'utilizzatore

Patologia utilizzatore:

Presenza di spasmi importanti o distonie: SI NO Peso utilizzatore (kg):.....Kg

Misure carrozzina - La tolleranza su tutte le dimensioni indicate e/o richieste è di ± 10 mm

Larghezza sedile (LS)

MODELLO ADULTO				MODELLO BAMBINO						
<input type="checkbox"/> 33	<input type="checkbox"/> 36	<input type="checkbox"/> 39	<input type="checkbox"/> 42	<input type="checkbox"/> 45	<input type="checkbox"/> 48	<input type="checkbox"/> 27	<input type="checkbox"/> 30	<input type="checkbox"/> 33	<input type="checkbox"/> 36	<input type="checkbox"/> 39
<input type="radio"/> Kit allargamento seduta (LS + 3cm) 09876 90,00 <input type="checkbox"/> Non montato <input type="checkbox"/> Montato				<input type="radio"/> Kit allargamento seduta (LS + 3cm) 11476 90,00 <input type="checkbox"/> Non montato <input type="checkbox"/> Montato						

Profondità sedile (PS) - regolabile!

Telaio corto	Telaio medio	Telaio lungo	Posizione tubo schienale
<input type="checkbox"/> 35 <input type="checkbox"/> 37,5 <input type="checkbox"/> 40 <p>(PS 40)</p>	<input type="checkbox"/> 40 <input type="checkbox"/> 42,5 <input type="checkbox"/> 45 <p>(PS 45)</p>	<input type="checkbox"/> 45 <input type="checkbox"/> 47,5 <input type="checkbox"/> 50 <p>(PS 50)</p>	

Distanza pedana (DP) - (Distanza tela sedile - piatto pedana)
 ATTENZIONE! Altezza anteriore minimo 4 cm maggiore della DISTANZA PEDANA
 Distanza pedana minima possibile ~22cm

.....(cm) ±0,5cm - step di regolazione 1,5cm

Altezza carrozzina (con seduta parallela al terreno)

	Ruote posteriori					Ruote posteriori			
	12"	16"	22"	24"		12"	16"	22"	24"
RUOTE ANTERIORI 6"	<input type="checkbox"/> 42 <input type="checkbox"/> 43,3 <input type="checkbox"/> 44,5 <input type="checkbox"/> 45,8 <input type="checkbox"/> 47	<input type="checkbox"/> 47 <input type="checkbox"/> 48,3	<input type="checkbox"/> 42 <input type="checkbox"/> 43,3 <input type="checkbox"/> 44,5 <input type="checkbox"/> 45,8	<input type="checkbox"/> 43,3 <input type="checkbox"/> 44,5 <input type="checkbox"/> 45,8 <input type="checkbox"/> 47 <input type="checkbox"/> 48,3	RUOTE ANTERIORI 7"	<input type="checkbox"/> 44,5 <input type="checkbox"/> 45,8 <input type="checkbox"/> 47	<input type="checkbox"/> 47 <input type="checkbox"/> 48,3	<input type="checkbox"/> 44,5 <input type="checkbox"/> 45,8	<input type="checkbox"/> 44,5 <input type="checkbox"/> 45,8 <input type="checkbox"/> 47 <input type="checkbox"/> 48,3

Telaio anteriore

☆ Telaio dritto (non disponibile per larghezza 27)

Telaio con abduzione 6cm non disponibile per larghezza 42 - 45 - 48
Distanza pedana massima possibile 42

Telaio anteriore elevabile, girevole ed estraibile non disponibile per larghezza 27 - 30 - 33
Distanza pedana minima possibile 25cm.

Telaio anteriore girevole ed estraibile

☆ 110° 120° 95°
 (Esclude l'installazione delle ruote anteriori 7")

Telaio anteriore girevole ed estraibile

☆ 95°
 (Non disponibile ruote anteriori 7")

Completo supporti polpaccio e di appoggiapiedi in plastica con fascia ferma talloni

09730 **220,00**

Email: info_1@permobil.com - web: http://www.rehateamprogeo.com

Data Commessa Utilizzatore Indirizzo

Colore telaio (senza aggiunta di prezzo)

- Nero opaco
 Blu AVIO
 Bianco perlato
 Arancio Opaco
 Tekno antracite
 Grigio opaco
 Rosso opaco

Colore telaio su richiesta

- Rosso brillante
 Fucsia brillante
 Lime brillante
 Blu china brillante

09729 **220,00**

Maniglione unico di spinta per accompagnatore

Maniglione di spinta con comando basculamento - REMOVIBILE

angolo regolabile

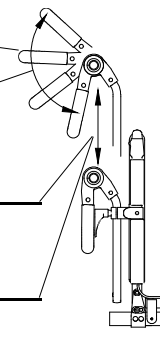

Con schienale fisso (non abbattibile) regolabile in altezza 30+70cm (Rispetto alla seduta)

Con schienale abbattibile regolabile in altezza 20+60cm (Rispetto alla seduta)

Schienale

☆ Schienale fisso (non abbattibile) angolo regolabile da -4° a +12°

Schienale abbattibile angolo regolabile da -4° a +12°

09728 **270,00**

Schienale reclinabile (Non abbattibile) inclinazione dinamica con molla a gas

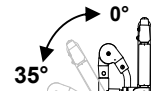

10090 **310,00**

La profondità seduta effettiva misurata da inizio tela sedile a tubo schienale risulta maggiorata di 1,5 cm

Imbottitura schienale

☆ SENZA schienale tensionabile imbottito traspirante.

Altezza schienale (TS) (std 42cm)

CON schienale tensionabile imbottito traspirante. Completo di patella di raccordo schienale/tela sedile.

04693 **120,00**

Con schienale fisso (non abbattibile)->altezza minima possibile 39cm

Altezza schienale (TS) (std 42cm)

Ruote anteriori

- 6" Piena Soft
 6" Pneumatica
 7" Piena Soft

Non disponibile con: Telaio anteriore 95°

Ruote posteriori

☆ Ruote da transito da 12" - Copertura piena

- Ruote da transito da 12" - Pneumatica
 Ruote da transito da 16" - Pneumatica
 24" Superleggera Standard Progeo
 22" Superleggera Standard Progeo
 24" Superleggera "Spinergy LX"
 24" Superleggera "Spinergy LXL" Raggi bianchi e mozzo nero Raggi e mozzo neri
 24" Superleggera "Spinergy Flex rim" Corrimano incorporato Alluminio/Gomma
 24" Fuoristrada (corrimano in alluminio nero)
 12" con freno a tamburo per accompagnatore Copertura piena Pneumatica
 16" con freno a tamburo per accompagnatore - Pneumatica
 22" con freno a tamburo per accompagnatore (corrimano in alluminio)
 24" con freno a tamburo per accompagnatore (corrimano in alluminio)

04696 **120,00**
 04696 **120,00**
 04691 **800,00**
 07848 **800,00**
 02270 **1.200,00**
 04690 **300,00**
 04105 **320,00**
 04107 **320,00**
 03385 **350,00**
 03384 **350,00**

Colore ruote posteriori

Solo le ruote standard Progeo 22"/24" hanno mozzi e cerchi colorati

- Nero 22" 24" 00833 **130,00**
 Argento brillante 22" 24" 00833 **130,00**
 Lime brillante 22" 24" 00833 **130,00**
 Azzurro brillante 22" 24" 00833 **130,00**
 Rosso brillante 22" 24" 00833 **130,00**
 Fucsia brillante 22" 24" 00833 **130,00**
 Bianco perlato 22" 24" 00833 **130,00**
 Tekno antracite 22" 24" 00833 **130,00**
 Blu notte opaco 22" 24" 00833 **130,00**
 Grigio opaco 22" 24" 00833 **130,00**
 Rosso opaco 22" 24" 00833 **130,00**

Cerchi di spinta

Distanza ruota ☆ 3 cm 4 cm

- Alluminio (22-24")
 Alluminio Nero SOFT-TOUCH (24") 09170 **110,00**
 Acciaio cromato (24") 01684 **170,00**
 Titanio (24") 00016 **270,00**
 Ultra Grepp (24") 00017 **300,00**
 Max Grepp (24") 00834 **330,00**

 TOP FRICTION (24") 11023 **290,00**
 Profilo ovale con inserto in gomma
 NOVA H (24") 11025 **270,00**
 Profilo ergonomico colore nero
 NOVA D (24") 11026 **290,00**
 Profilo ergonomico con rivestimento in gomma (ideale per tetraplegici)

 Timone (24") 00693 **200,00**
 Anello anti scivolo in silicone applicabile su cerchio in alluminio 04050 **170,00**

Rehateam s.r.l. Vicolo Negrelli, 5 - 31038 Castagnole di Paese (TV) - Tel. +39 0422 484657/+39 0422 480387 - Fax +39 0422 484661/+39 0422 484684 - P.IVA IT 03182520266 - C.C.I.A.A. TV n.41690 Capitale Sociale I.V. Euro 100.000,00
 la società è soggetta ex art. 2497-bis C.C. al coordinamento e direzione della società "PERMOBIL ITALY SRL" iscritta al Registro Imprese Milano Monza Brianza Lodi 10246110968

Email: info_it@permobil.com - web: http://www.rehateamprogeo.com

Rehateam s.r.l. Vicolo Negrelli, 5 - 31038 Castagnole di Paese (TV) - Tel. +39.0422.484657/+39.0422.480387 - Fax +39.0422.484661/+39.0422.484684 - P.IVA IT 03182520266 - C.C.I.A.A. TV n.225867 - Iscr. Trib. TV n.41690 Capitale Sociale i.V. Euro 100.000,00
 la società è soggetta ex art. 2497-bis C.C. al coordinamento e direzione della società "PERMOBIL ITALY SRL" iscritta al Registro Imprese Milano Monza Brianza Lodi 10246110968

Data	Commessa	Utilizzatore	Indirizzo
------------	----------------	--------------------	-----------------

Copertura ruota posteriore			
<input checked="" type="checkbox"/> Liscio Alta Pressione	(22-24")		
<input type="checkbox"/> Tassellato Alta Pressione	(24")		
<input type="checkbox"/> Marathon Plus	(24")	con protezione anti foratura	01669 65,00
<input type="checkbox"/> Copertura piena - Colore Grigio	(22")		04181 110,00
<input type="checkbox"/> Copertura piena - Colore Nero	(24")		11083 110,00
Non disponibile con Ruote posteriori: 24" Superleggere "Spinergy LXL"			

Freni			
<input checked="" type="checkbox"/> Freno leva curva da spingere			
<input type="checkbox"/> Freno leva dritta da spingere			
<input type="checkbox"/> Freno leva dritta da tirare			
<input type="checkbox"/> Freno con leva prolungata da spingere			01949 70,00
<input type="checkbox"/> Freno con leva prolungata da tirare			03372 70,00

Pedana (Non disponibile con Telaio anteriore elevabile, girevole ed estraibile)			
<input checked="" type="checkbox"/> Pedana sdoppiata in plastica, regolabile in inclinazione			11525
Distanza pedana minima possibile ~22cm			
Non disponibile con: Telaio anteriore con pedana elevabile, girevole ed estraibile			
<input type="checkbox"/> Pedana unica alzabile in alluminio regolabile in profondità e inclinazione			09727 130,00
Non disponibile per larghezza 27-30 con telaio anteriore dritto			
Distanza pedana minima possibile ~21cm			
Non disponibile con: Telaio anteriore con pedana elevabile, girevole ed estraibile			
<input type="checkbox"/> interna <input checked="" type="checkbox"/> 2/3 interna <input type="checkbox"/> 2/3 esterna <input type="checkbox"/> esterna			

Braccioli estraibili CON protezione vestiario integrata			
<input checked="" type="checkbox"/> Braccioli Desk PROGEO	(Estraibili regolabili in altezza)		
<input type="checkbox"/> Braccioli estraibili con protezione dritta in ABS	(Estraibili regolabili in altezza)		
Distanza tela sedile - imbottitura bracciolo (cm) <input type="checkbox"/> 21 <input type="checkbox"/> 23 <input type="checkbox"/> 25 <input checked="" type="checkbox"/> 27 <input type="checkbox"/> 29			

SAFETY			
<input type="checkbox"/> Sistema di ancoraggio a 4 punti per fissaggio carrozzina			08654 190,00
E' obbligatorio l'utilizzo di un appoggiatesta durante il trasporto (l'installazione deve essere eseguita dalla casa costruttrice)			

Accessori			
<input type="checkbox"/> Imbottitura paracolpi telaio anteriore			07058 50,00
<input type="checkbox"/> Borsello portaoggetti removibile (con aggancio rapido)			09811 120,00

Optional 1			
<input checked="" type="checkbox"/> Ruota antiribaltamento con aggancio rapido	(rotazione all'interno per ridurre l'ingombro)		
FORNITE DI SERIE			
<input type="checkbox"/> Poggiatesta Super Head Multiadattabile	(sistema pieghevole con la carrozzina)		11477 360,00
<input type="checkbox"/> Ruote ascensore			00836 170,00
<input type="checkbox"/> Aiuto ribaltamento	<input type="checkbox"/> Destro		00025 90,00
	<input type="checkbox"/> Sinistro		01046 90,00
<input type="checkbox"/> Porta stampelle	<input type="checkbox"/> Destro		00838 80,00
	<input type="checkbox"/> Sinistro		00837 80,00

Optional 2			
<input type="checkbox"/> Cinghia di bretellaggio			04103 130,00
<input type="checkbox"/> Cinghia pelvica di ancoraggio			03972 70,00
<input type="checkbox"/> Tavolino (estraibile)			00508 260,00
<input type="checkbox"/> Supporto lombare	(da inserire all'interno dello schienale)		00013 50,00
<input type="checkbox"/> Copriraggi Nero	(22-24")		01043 160,00
<input type="checkbox"/> Copriraggi Trasparente	(22-24")		00835 160,00
<input type="checkbox"/> Copriraggi Colorato Progeo Design	(22-24")		00019 180,00
<input type="checkbox"/> Copriraggi Dragon	(22-24")		02106 180,00

Email: info_it@permobil.com - web: http://www.rehateamprogeo.com

Data Commessa Utilizzatore Indirizzo

PHYSIO - Imbottitura schienale originale non fornita

Estraibile con aggancio rapido
 Installazione su tubi diametro 18÷26mm
 Regolazione in profondità (4cm)
 Regolazione inclinazione (±18°)

Schienale posturale VERSIONE KID BAMBINO

- KID** Guscio ALLUMINIO

ATTENZIONE con questo schienale si riduce la profondità della seduta di circa 5cm.

ALTEZZA SCHIENALE	29	34	40
Conformazione del guscio 	Ala di contenimento laterale R=regolare		
	R	R	R
	<input type="checkbox"/>	<input type="checkbox"/>	<input type="checkbox"/>

810,00

Schienale posturale VERSIONE ADULTO

- AIR** Guscio CARBONIO
 non disponibile per larghezza 27 - 30

ALTEZZA SCHIENALE	28	34	40			
Conformazione del guscio 	Ala di contenimento laterale A=alta - R=regolare					
	A	R	A	R	A	R
	<input type="checkbox"/>	<input type="checkbox"/>	<input type="checkbox"/>	<input type="checkbox"/>	<input type="checkbox"/>	<input type="checkbox"/>

860,00

- POSTURE** Guscio ALLUMINIO
 non disponibile per larghezza 27 - 30

ALTEZZA SCHIENALE	34	40	52
Conformazione del guscio 	Ala di contenimento laterale R=regolare		
	R	R	R
	<input type="checkbox"/>	<input type="checkbox"/>	<input type="checkbox"/>

810,00

Configurazione DEEP con PAD per contenimento laterale (regolabili in altezza)

- Pad in alluminio con imbottitura e rivestimento in tessuto traspirante



Piccolo (h 13cm)



Destro
10272

40,00

Sinistro
10272

40,00

Grande (h 20cm)



Destro
10273

50,00

Sinistro
10273

50,00

Rehateam s.r.l. Vicolo Negrelli, 5 - 31038 Castagnole di Paese (TV) - Tel. +39.0422.484657/+39.0422.480387 - Fax +39.0422.484661/+39.0422.484684 - P.IVA IT 03182520266 - C.C.I.A.A. TV n.41690 Capitale Sociale i.V. Euro 100.000,00
 la società è soggetta ex art. 2497-bis C.C. al coordinamento e direzione della società "PERMOBIL ITALY SRL" iscritta al Registro Imprese Milano Monza Brianza Lodi 10246110968

Email: info_it@permobil.com - web: http://www.rehateamprogeo.com

Data Commessa Utilizzatore Indirizzo

Accessori

KID AIR POSTURE

○ Supporti toracici (spinta laterale) - SWING AWAY - Girevole
Non disponibile su schienale Physio AIR Guscio in Carbonio
Hardware di fissaggio e regolazione completi di imbottitura paracolpi
Pad in alluminio con imbottitura e rivestimento in tessuto traspirante

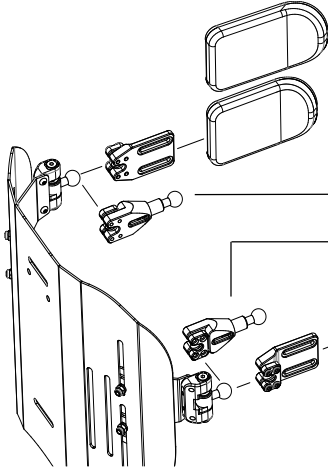

○ Grande (18x12) 05647 170,00

○ Piccola (14x9) 05643 170,00

○ Prolunga supporto toracico Quantità (n° pz)..... 10271 60,00

○ Prolunga supporto toracico Quantità (n° pz).....

○ Piccola (14x9) 05642 170,00

○ Grande (18x12) 05646 170,00

○ Poggiatesta multiregolazione - sistema di montaggio a doppia sfera
Disponibile solo su schienale Physio Posture e Kid

Grande (34x14) 05648 360,00
 Piccola (28x14)





Cuscini antidecubito e posturali a nido d'ape STIMULITE

○ Classic H 7 cm. 36x41 00035 38x38 00036 38x41 01052 41x41 00037  630,00
 41x46 00840 46x41 00698 46x46 00038

○ Anatomico Posturale H 10 cm. 36x41 00056 38x38 00696 38x41 00032 41x41 00033  630,00
 41x46 01050 46x41 00034 46x46 01051

○ Slimline sagomato H 5 cm. 36x41 00854 38x38 00707 38x41 00083 41x41 01073  630,00
 41x46 00085 46x41 01074 46x46 01075

○ Sport H 5 cm. 36x41 00053 38x38 00054 38x41 01060 41x41 01061  600,00
 41x46 00057 46x41 01062 46x46 00846

○ Silver H 3,5 cm. 41x41 00641 41x46 01353 46x41 00642 46x46 01022  600,00

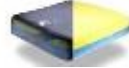
○ Corbee Pediatrico H 5 cm. 25x25 00052 30x30 00845 36x36 00079  630,00

○ Pediatrico anatomico posturale H 6 cm. 25x25 00638 30x30 01351 36x36 00639  630,00







Misura cliente Larghezza cm. Profondità cm.

○ Supporto lombare STIMULITE  00064 220,00

Rehateam s.r.l. Vicolo Negrelli, 5 - 31038 Castagnole di Paese (TV) - Tel. +39 0422 484657/+39 0422 480387 - Fax +39 0422 484654/+39 0422 484654 - P.IVA IT 03182520266 - C.C.I.A.A. TV n.41690 Capitale Sociale I.V. Euro 100.000,00 la società è soggetta ex art. 2497-bis C.C. al coordinamento e direzione della società "PERMOBIL ITALY SRL" iscritta al Registro Imprese Milano Monza Brianza Lodi 10246110968

Email: info_it@permobil.com - web: http://www.rehateamprogeo.com

Carrozzina : Progeo TEKNA TILT 2.0 - Rev. 2024.1	Prezzo IVA esclusa da sommare al prezzo di listino	Pagina da inviare se sono stati scelti optional	
		<input checked="" type="checkbox"/> standard (fornito in assenza di altre indicazioni)	<input type="checkbox"/> su richiesta (senza aggiunta di prezzo)
		<input type="checkbox"/> optional (sommare il prezzo a quello di listino)	

Data	Commessa	Utilizzatore	Indirizzo																																																																								
ROHO® MOSAIC® - H7cm - Limite di peso 143Kg 200,00																																																																											
<table border="1"> <thead> <tr> <th>Misure cuscino LxP</th> <th>Adatto a seduta LSxPS</th> <th>Codice</th> </tr> </thead> <tbody> <tr><td><input type="checkbox"/> 41 x 41</td><td>42 x 42</td><td>MOS1616HD</td></tr> <tr><td><input type="checkbox"/> 41 x 46</td><td>42 x 47</td><td>MOS1618HD</td></tr> <tr><td><input type="checkbox"/> 44 x 44</td><td>44 x 44</td><td>MOS1717HD</td></tr> </tbody> </table>	Misure cuscino LxP	Adatto a seduta LSxPS	Codice	<input type="checkbox"/> 41 x 41	42 x 42	MOS1616HD	<input type="checkbox"/> 41 x 46	42 x 47	MOS1618HD	<input type="checkbox"/> 44 x 44	44 x 44	MOS1717HD	<table border="1"> <thead> <tr> <th>Misure cuscino LxP</th> <th>Adatto a seduta LSxPS</th> <th>Codice</th> </tr> </thead> <tbody> <tr><td><input type="checkbox"/> 46 x 41</td><td>47 x 42</td><td>MOS1816HD</td></tr> <tr><td><input type="checkbox"/> 46 x 46</td><td>47 x 47</td><td>MOS1818HD</td></tr> <tr><td><input type="checkbox"/> 51 x 46</td><td>52 x 47</td><td>MOS2018HD</td></tr> </tbody> </table>	Misure cuscino LxP	Adatto a seduta LSxPS	Codice	<input type="checkbox"/> 46 x 41	47 x 42	MOS1816HD	<input type="checkbox"/> 46 x 46	47 x 47	MOS1818HD	<input type="checkbox"/> 51 x 46	52 x 47	MOS2018HD																																																		
Misure cuscino LxP	Adatto a seduta LSxPS	Codice																																																																									
<input type="checkbox"/> 41 x 41	42 x 42	MOS1616HD																																																																									
<input type="checkbox"/> 41 x 46	42 x 47	MOS1618HD																																																																									
<input type="checkbox"/> 44 x 44	44 x 44	MOS1717HD																																																																									
Misure cuscino LxP	Adatto a seduta LSxPS	Codice																																																																									
<input type="checkbox"/> 46 x 41	47 x 42	MOS1816HD																																																																									
<input type="checkbox"/> 46 x 46	47 x 47	MOS1818HD																																																																									
<input type="checkbox"/> 51 x 46	52 x 47	MOS2018HD																																																																									
ROHO® AIR LITE® - H9,5cm - Limite di peso 136Kg 200,00																																																																											
<table border="1"> <thead> <tr> <th>Misure cuscino LxP</th> <th>Codice</th> </tr> </thead> <tbody> <tr><td><input type="checkbox"/> 33 x 33</td><td>AL1313HD</td></tr> <tr><td><input type="checkbox"/> 33 x 38</td><td>AL1315HD</td></tr> <tr><td><input type="checkbox"/> 36 x 36</td><td>AL1414HD</td></tr> <tr><td><input type="checkbox"/> 36 x 41</td><td>AL1416HD</td></tr> <tr><td><input type="checkbox"/> 38 x 38</td><td>AL1515HD</td></tr> <tr><td><input type="checkbox"/> 38 x 43</td><td>AL1517HD</td></tr> <tr><td><input type="checkbox"/> 41 x 41</td><td>AL1616HD</td></tr> <tr><td><input type="checkbox"/> 41 x 46</td><td>AL1618HD</td></tr> <tr><td><input type="checkbox"/> 43 x 43</td><td>AL1717HD</td></tr> </tbody> </table>	Misure cuscino LxP	Codice	<input type="checkbox"/> 33 x 33	AL1313HD	<input type="checkbox"/> 33 x 38	AL1315HD	<input type="checkbox"/> 36 x 36	AL1414HD	<input type="checkbox"/> 36 x 41	AL1416HD	<input type="checkbox"/> 38 x 38	AL1515HD	<input type="checkbox"/> 38 x 43	AL1517HD	<input type="checkbox"/> 41 x 41	AL1616HD	<input type="checkbox"/> 41 x 46	AL1618HD	<input type="checkbox"/> 43 x 43	AL1717HD	<table border="1"> <thead> <tr> <th>Misure cuscino LxP</th> <th>Codice</th> </tr> </thead> <tbody> <tr><td><input type="checkbox"/> 43 x 46</td><td>AL1718HD</td></tr> <tr><td><input type="checkbox"/> 43 x 51</td><td>AL1720HD</td></tr> <tr><td><input type="checkbox"/> 46 x 41</td><td>AL1816HD</td></tr> <tr><td><input type="checkbox"/> 46 x 46</td><td>AL1818HD</td></tr> <tr><td><input type="checkbox"/> 46 x 51</td><td>AL1820HD</td></tr> <tr><td><input type="checkbox"/> 48 x 43</td><td>AL1917HD</td></tr> <tr><td><input type="checkbox"/> 48 x 48</td><td>AL1919HD</td></tr> <tr><td><input type="checkbox"/> 51 x 43</td><td>AL2017HD</td></tr> <tr><td><input type="checkbox"/> 51 x 46</td><td>AL2018HD</td></tr> </tbody> </table>	Misure cuscino LxP	Codice	<input type="checkbox"/> 43 x 46	AL1718HD	<input type="checkbox"/> 43 x 51	AL1720HD	<input type="checkbox"/> 46 x 41	AL1816HD	<input type="checkbox"/> 46 x 46	AL1818HD	<input type="checkbox"/> 46 x 51	AL1820HD	<input type="checkbox"/> 48 x 43	AL1917HD	<input type="checkbox"/> 48 x 48	AL1919HD	<input type="checkbox"/> 51 x 43	AL2017HD	<input type="checkbox"/> 51 x 46	AL2018HD																																		
Misure cuscino LxP	Codice																																																																										
<input type="checkbox"/> 33 x 33	AL1313HD																																																																										
<input type="checkbox"/> 33 x 38	AL1315HD																																																																										
<input type="checkbox"/> 36 x 36	AL1414HD																																																																										
<input type="checkbox"/> 36 x 41	AL1416HD																																																																										
<input type="checkbox"/> 38 x 38	AL1515HD																																																																										
<input type="checkbox"/> 38 x 43	AL1517HD																																																																										
<input type="checkbox"/> 41 x 41	AL1616HD																																																																										
<input type="checkbox"/> 41 x 46	AL1618HD																																																																										
<input type="checkbox"/> 43 x 43	AL1717HD																																																																										
Misure cuscino LxP	Codice																																																																										
<input type="checkbox"/> 43 x 46	AL1718HD																																																																										
<input type="checkbox"/> 43 x 51	AL1720HD																																																																										
<input type="checkbox"/> 46 x 41	AL1816HD																																																																										
<input type="checkbox"/> 46 x 46	AL1818HD																																																																										
<input type="checkbox"/> 46 x 51	AL1820HD																																																																										
<input type="checkbox"/> 48 x 43	AL1917HD																																																																										
<input type="checkbox"/> 48 x 48	AL1919HD																																																																										
<input type="checkbox"/> 51 x 43	AL2017HD																																																																										
<input type="checkbox"/> 51 x 46	AL2018HD																																																																										
ROHO® HYBRID ELITE SR® - Monovalvola - Sensor Ready - Limite di peso 225Kg 630,00																																																																											
<table border="1"> <thead> <tr> <th>Misure cuscino LxP</th> <th>Adatto a seduta LSxPS</th> <th>Codice</th> </tr> </thead> <tbody> <tr><td><input type="checkbox"/> 35 x 37,5</td><td>36 x 36</td><td>1RHE1414C-SR</td></tr> <tr><td><input type="checkbox"/> 35 x 40</td><td>36 x 38</td><td>1RHE1415C-SR</td></tr> <tr><td><input type="checkbox"/> 35 x 43</td><td>36 x 41</td><td>1RHE1416C-SR</td></tr> <tr><td><input type="checkbox"/> 37,5 x 40</td><td>38 x 38</td><td>1RHE1515C-SR</td></tr> <tr><td><input type="checkbox"/> 37,5 x 43</td><td>38 x 41</td><td>1RHE1516C-SR</td></tr> <tr><td><input type="checkbox"/> 37,5 x 45</td><td>38 x 43</td><td>1RHE1517C-SR</td></tr> <tr><td><input type="checkbox"/> 40 x 40</td><td>41 x 38</td><td>1RHE1615C-SR</td></tr> <tr><td><input type="checkbox"/> 40 x 43</td><td>41 x 41</td><td>1RHE1616C-SR</td></tr> <tr><td><input type="checkbox"/> 40 x 45</td><td>41 x 43</td><td>1RHE1617C-SR</td></tr> <tr><td><input type="checkbox"/> 40 x 48</td><td>41 x 46</td><td>1RHE1618C-SR</td></tr> <tr><td><input type="checkbox"/> 40 x 53</td><td>41 x 51</td><td>1RHE1620C-SR</td></tr> </tbody> </table>	Misure cuscino LxP	Adatto a seduta LSxPS	Codice	<input type="checkbox"/> 35 x 37,5	36 x 36	1RHE1414C-SR	<input type="checkbox"/> 35 x 40	36 x 38	1RHE1415C-SR	<input type="checkbox"/> 35 x 43	36 x 41	1RHE1416C-SR	<input type="checkbox"/> 37,5 x 40	38 x 38	1RHE1515C-SR	<input type="checkbox"/> 37,5 x 43	38 x 41	1RHE1516C-SR	<input type="checkbox"/> 37,5 x 45	38 x 43	1RHE1517C-SR	<input type="checkbox"/> 40 x 40	41 x 38	1RHE1615C-SR	<input type="checkbox"/> 40 x 43	41 x 41	1RHE1616C-SR	<input type="checkbox"/> 40 x 45	41 x 43	1RHE1617C-SR	<input type="checkbox"/> 40 x 48	41 x 46	1RHE1618C-SR	<input type="checkbox"/> 40 x 53	41 x 51	1RHE1620C-SR	<table border="1"> <thead> <tr> <th>Misure cuscino LxP</th> <th>Adatto a seduta LSxPS</th> <th>Codice</th> </tr> </thead> <tbody> <tr><td><input type="checkbox"/> 43 x 43</td><td>43 x 41</td><td>1RHE1716C-SR</td></tr> <tr><td><input type="checkbox"/> 43 x 45</td><td>43 x 43</td><td>1RHE1717C-SR</td></tr> <tr><td><input type="checkbox"/> 43 x 48</td><td>43 x 46</td><td>1RHE1718C-SR</td></tr> <tr><td><input type="checkbox"/> 43 x 53</td><td>43 x 51</td><td>1RHE1720C-SR</td></tr> <tr><td><input type="checkbox"/> 45 x 43</td><td>46 x 41</td><td>1RHE1816C-SR</td></tr> <tr><td><input type="checkbox"/> 45 x 45</td><td>46 x 43</td><td>1RHE1817C-SR</td></tr> <tr><td><input type="checkbox"/> 45 x 48</td><td>46 x 46</td><td>1RHE1818C-SR</td></tr> <tr><td><input type="checkbox"/> 45 x 53</td><td>46 x 51</td><td>1RHE1820C-SR</td></tr> <tr><td><input type="checkbox"/> 50 x 45</td><td>51 x 43</td><td>1RHE2017C-SR</td></tr> <tr><td><input type="checkbox"/> 50 x 48</td><td>51 x 46</td><td>1RHE2018C-SR</td></tr> <tr><td><input type="checkbox"/> 50 x 53</td><td>51 x 51</td><td>1RHE2020C-SR</td></tr> </tbody> </table>	Misure cuscino LxP	Adatto a seduta LSxPS	Codice	<input type="checkbox"/> 43 x 43	43 x 41	1RHE1716C-SR	<input type="checkbox"/> 43 x 45	43 x 43	1RHE1717C-SR	<input type="checkbox"/> 43 x 48	43 x 46	1RHE1718C-SR	<input type="checkbox"/> 43 x 53	43 x 51	1RHE1720C-SR	<input type="checkbox"/> 45 x 43	46 x 41	1RHE1816C-SR	<input type="checkbox"/> 45 x 45	46 x 43	1RHE1817C-SR	<input type="checkbox"/> 45 x 48	46 x 46	1RHE1818C-SR	<input type="checkbox"/> 45 x 53	46 x 51	1RHE1820C-SR	<input type="checkbox"/> 50 x 45	51 x 43	1RHE2017C-SR	<input type="checkbox"/> 50 x 48	51 x 46	1RHE2018C-SR	<input type="checkbox"/> 50 x 53	51 x 51	1RHE2020C-SR		
Misure cuscino LxP	Adatto a seduta LSxPS	Codice																																																																									
<input type="checkbox"/> 35 x 37,5	36 x 36	1RHE1414C-SR																																																																									
<input type="checkbox"/> 35 x 40	36 x 38	1RHE1415C-SR																																																																									
<input type="checkbox"/> 35 x 43	36 x 41	1RHE1416C-SR																																																																									
<input type="checkbox"/> 37,5 x 40	38 x 38	1RHE1515C-SR																																																																									
<input type="checkbox"/> 37,5 x 43	38 x 41	1RHE1516C-SR																																																																									
<input type="checkbox"/> 37,5 x 45	38 x 43	1RHE1517C-SR																																																																									
<input type="checkbox"/> 40 x 40	41 x 38	1RHE1615C-SR																																																																									
<input type="checkbox"/> 40 x 43	41 x 41	1RHE1616C-SR																																																																									
<input type="checkbox"/> 40 x 45	41 x 43	1RHE1617C-SR																																																																									
<input type="checkbox"/> 40 x 48	41 x 46	1RHE1618C-SR																																																																									
<input type="checkbox"/> 40 x 53	41 x 51	1RHE1620C-SR																																																																									
Misure cuscino LxP	Adatto a seduta LSxPS	Codice																																																																									
<input type="checkbox"/> 43 x 43	43 x 41	1RHE1716C-SR																																																																									
<input type="checkbox"/> 43 x 45	43 x 43	1RHE1717C-SR																																																																									
<input type="checkbox"/> 43 x 48	43 x 46	1RHE1718C-SR																																																																									
<input type="checkbox"/> 43 x 53	43 x 51	1RHE1720C-SR																																																																									
<input type="checkbox"/> 45 x 43	46 x 41	1RHE1816C-SR																																																																									
<input type="checkbox"/> 45 x 45	46 x 43	1RHE1817C-SR																																																																									
<input type="checkbox"/> 45 x 48	46 x 46	1RHE1818C-SR																																																																									
<input type="checkbox"/> 45 x 53	46 x 51	1RHE1820C-SR																																																																									
<input type="checkbox"/> 50 x 45	51 x 43	1RHE2017C-SR																																																																									
<input type="checkbox"/> 50 x 48	51 x 46	1RHE2018C-SR																																																																									
<input type="checkbox"/> 50 x 53	51 x 51	1RHE2020C-SR																																																																									
ROHO® HYBRID ELITE® - Bivalvola /Bicompartimento - Limite di peso 225Kg 630,00																																																																											
<table border="1"> <thead> <tr> <th>Misure cuscino LxP</th> <th>Adatto a seduta LSxPS</th> <th>Codice</th> </tr> </thead> <tbody> <tr><td><input type="checkbox"/> 35 x 37,5</td><td>36 x 36</td><td>2RHE1414C</td></tr> <tr><td><input type="checkbox"/> 35 x 40</td><td>36 x 38</td><td>2RHE1415C</td></tr> <tr><td><input type="checkbox"/> 35 x 43</td><td>36 x 41</td><td>2RHE1416C</td></tr> <tr><td><input type="checkbox"/> 37,5 x 40</td><td>38 x 38</td><td>2RHE1515C</td></tr> <tr><td><input type="checkbox"/> 37,5 x 43</td><td>38 x 41</td><td>2RHE1516C</td></tr> <tr><td><input type="checkbox"/> 37,5 x 45</td><td>38 x 43</td><td>2RHE1517C</td></tr> <tr><td><input type="checkbox"/> 40 x 40</td><td>41 x 38</td><td>2RHE1615C</td></tr> <tr><td><input type="checkbox"/> 40 x 43</td><td>41 x 41</td><td>2RHE1616C</td></tr> <tr><td><input type="checkbox"/> 40 x 45</td><td>41 x 43</td><td>2RHE1617C</td></tr> <tr><td><input type="checkbox"/> 40 x 48</td><td>41 x 46</td><td>2RHE1618C</td></tr> <tr><td><input type="checkbox"/> 40 x 53</td><td>41 x 51</td><td>2RHE1620C</td></tr> </tbody> </table>	Misure cuscino LxP	Adatto a seduta LSxPS	Codice	<input type="checkbox"/> 35 x 37,5	36 x 36	2RHE1414C	<input type="checkbox"/> 35 x 40	36 x 38	2RHE1415C	<input type="checkbox"/> 35 x 43	36 x 41	2RHE1416C	<input type="checkbox"/> 37,5 x 40	38 x 38	2RHE1515C	<input type="checkbox"/> 37,5 x 43	38 x 41	2RHE1516C	<input type="checkbox"/> 37,5 x 45	38 x 43	2RHE1517C	<input type="checkbox"/> 40 x 40	41 x 38	2RHE1615C	<input type="checkbox"/> 40 x 43	41 x 41	2RHE1616C	<input type="checkbox"/> 40 x 45	41 x 43	2RHE1617C	<input type="checkbox"/> 40 x 48	41 x 46	2RHE1618C	<input type="checkbox"/> 40 x 53	41 x 51	2RHE1620C	<table border="1"> <thead> <tr> <th>Misure cuscino LxP</th> <th>Adatto a seduta LSxPS</th> <th>Codice</th> </tr> </thead> <tbody> <tr><td><input type="checkbox"/> 43 x 43</td><td>43 x 41</td><td>2RHE1716C</td></tr> <tr><td><input type="checkbox"/> 43 x 45</td><td>43 x 43</td><td>2RHE1717C</td></tr> <tr><td><input type="checkbox"/> 43 x 48</td><td>43 x 46</td><td>2RHE1718C</td></tr> <tr><td><input type="checkbox"/> 43 x 53</td><td>43 x 51</td><td>2RHE1720C</td></tr> <tr><td><input type="checkbox"/> 45 x 43</td><td>46 x 41</td><td>2RHE1816C</td></tr> <tr><td><input type="checkbox"/> 45 x 45</td><td>46 x 43</td><td>2RHE1817C</td></tr> <tr><td><input type="checkbox"/> 45 x 48</td><td>46 x 46</td><td>2RHE1818C</td></tr> <tr><td><input type="checkbox"/> 45 x 53</td><td>46 x 51</td><td>2RHE1820C</td></tr> <tr><td><input type="checkbox"/> 50 x 45</td><td>51 x 43</td><td>2RHE2017C</td></tr> <tr><td><input type="checkbox"/> 50 x 48</td><td>51 x 46</td><td>2RHE2018C</td></tr> <tr><td><input type="checkbox"/> 50 x 53</td><td>51 x 51</td><td>2RHE2020C</td></tr> </tbody> </table>	Misure cuscino LxP	Adatto a seduta LSxPS	Codice	<input type="checkbox"/> 43 x 43	43 x 41	2RHE1716C	<input type="checkbox"/> 43 x 45	43 x 43	2RHE1717C	<input type="checkbox"/> 43 x 48	43 x 46	2RHE1718C	<input type="checkbox"/> 43 x 53	43 x 51	2RHE1720C	<input type="checkbox"/> 45 x 43	46 x 41	2RHE1816C	<input type="checkbox"/> 45 x 45	46 x 43	2RHE1817C	<input type="checkbox"/> 45 x 48	46 x 46	2RHE1818C	<input type="checkbox"/> 45 x 53	46 x 51	2RHE1820C	<input type="checkbox"/> 50 x 45	51 x 43	2RHE2017C	<input type="checkbox"/> 50 x 48	51 x 46	2RHE2018C	<input type="checkbox"/> 50 x 53	51 x 51	2RHE2020C		
Misure cuscino LxP	Adatto a seduta LSxPS	Codice																																																																									
<input type="checkbox"/> 35 x 37,5	36 x 36	2RHE1414C																																																																									
<input type="checkbox"/> 35 x 40	36 x 38	2RHE1415C																																																																									
<input type="checkbox"/> 35 x 43	36 x 41	2RHE1416C																																																																									
<input type="checkbox"/> 37,5 x 40	38 x 38	2RHE1515C																																																																									
<input type="checkbox"/> 37,5 x 43	38 x 41	2RHE1516C																																																																									
<input type="checkbox"/> 37,5 x 45	38 x 43	2RHE1517C																																																																									
<input type="checkbox"/> 40 x 40	41 x 38	2RHE1615C																																																																									
<input type="checkbox"/> 40 x 43	41 x 41	2RHE1616C																																																																									
<input type="checkbox"/> 40 x 45	41 x 43	2RHE1617C																																																																									
<input type="checkbox"/> 40 x 48	41 x 46	2RHE1618C																																																																									
<input type="checkbox"/> 40 x 53	41 x 51	2RHE1620C																																																																									
Misure cuscino LxP	Adatto a seduta LSxPS	Codice																																																																									
<input type="checkbox"/> 43 x 43	43 x 41	2RHE1716C																																																																									
<input type="checkbox"/> 43 x 45	43 x 43	2RHE1717C																																																																									
<input type="checkbox"/> 43 x 48	43 x 46	2RHE1718C																																																																									
<input type="checkbox"/> 43 x 53	43 x 51	2RHE1720C																																																																									
<input type="checkbox"/> 45 x 43	46 x 41	2RHE1816C																																																																									
<input type="checkbox"/> 45 x 45	46 x 43	2RHE1817C																																																																									
<input type="checkbox"/> 45 x 48	46 x 46	2RHE1818C																																																																									
<input type="checkbox"/> 45 x 53	46 x 51	2RHE1820C																																																																									
<input type="checkbox"/> 50 x 45	51 x 43	2RHE2017C																																																																									
<input type="checkbox"/> 50 x 48	51 x 46	2RHE2018C																																																																									
<input type="checkbox"/> 50 x 53	51 x 51	2RHE2020C																																																																									
ROHO® HYBRID SELECT® 630,00																																																																											
<table border="1"> <thead> <tr> <th>Misure cuscino LxP</th> <th>Adatto a seduta LSxPS</th> <th>Codice</th> </tr> </thead> <tbody> <tr><td><input type="checkbox"/> 35,5 x 37,5</td><td>36x38</td><td>HS1414C</td></tr> <tr><td><input type="checkbox"/> 35,5 x 42,5</td><td>36x43</td><td>HS1416C</td></tr> <tr><td><input type="checkbox"/> 38 x 40</td><td>38x40</td><td>HS1515C</td></tr> <tr><td><input type="checkbox"/> 38 x 42,5</td><td>38x43</td><td>HS1516C</td></tr> <tr><td><input type="checkbox"/> 38 x 45</td><td>38x45</td><td>HS1517C</td></tr> <tr><td><input type="checkbox"/> 40,5 x 40</td><td>41x40</td><td>HS1615C</td></tr> <tr><td><input type="checkbox"/> 40,5 x 42,5</td><td>41x43</td><td>HS1616C</td></tr> <tr><td><input type="checkbox"/> 40,5 x 45</td><td>41x45</td><td>HS1617C</td></tr> <tr><td><input type="checkbox"/> 40,5 x 47,5</td><td>41x48</td><td>HS1618C</td></tr> <tr><td><input type="checkbox"/> 40,5 x 52,5</td><td>41x53</td><td>HS1620C</td></tr> <tr><td><input type="checkbox"/> 43 x 42,5</td><td>43x43</td><td>HS1716C</td></tr> </tbody> </table>	Misure cuscino LxP	Adatto a seduta LSxPS	Codice	<input type="checkbox"/> 35,5 x 37,5	36x38	HS1414C	<input type="checkbox"/> 35,5 x 42,5	36x43	HS1416C	<input type="checkbox"/> 38 x 40	38x40	HS1515C	<input type="checkbox"/> 38 x 42,5	38x43	HS1516C	<input type="checkbox"/> 38 x 45	38x45	HS1517C	<input type="checkbox"/> 40,5 x 40	41x40	HS1615C	<input type="checkbox"/> 40,5 x 42,5	41x43	HS1616C	<input type="checkbox"/> 40,5 x 45	41x45	HS1617C	<input type="checkbox"/> 40,5 x 47,5	41x48	HS1618C	<input type="checkbox"/> 40,5 x 52,5	41x53	HS1620C	<input type="checkbox"/> 43 x 42,5	43x43	HS1716C	<table border="1"> <thead> <tr> <th>Misure cuscino LxP</th> <th>Adatto a seduta LSxPS</th> <th>Codice</th> </tr> </thead> <tbody> <tr><td><input type="checkbox"/> 43 x 45</td><td>43x45</td><td>HS1717C</td></tr> <tr><td><input type="checkbox"/> 43 x 47,5</td><td>43x48</td><td>HS1718C</td></tr> <tr><td><input type="checkbox"/> 43 x 52,5</td><td>43x53</td><td>HS1720C</td></tr> <tr><td><input type="checkbox"/> 45,5 x 42,5</td><td>46x43</td><td>HS1816C</td></tr> <tr><td><input type="checkbox"/> 45,5 x 45</td><td>46x45</td><td>HS1817C</td></tr> <tr><td><input type="checkbox"/> 45,5 x 47,5</td><td>46x48</td><td>HS1818C</td></tr> <tr><td><input type="checkbox"/> 45,5 x 52,5</td><td>46x53</td><td>HS1820C</td></tr> <tr><td><input type="checkbox"/> 51 x 42,5</td><td>51x43</td><td>HS2016C</td></tr> <tr><td><input type="checkbox"/> 51 x 45</td><td>51x45</td><td>HS2017C</td></tr> <tr><td><input type="checkbox"/> 51 x 47,5</td><td>51x48</td><td>HS2018C</td></tr> <tr><td><input type="checkbox"/> 51 x 52,5</td><td>51x53</td><td>HS2020C</td></tr> </tbody> </table>	Misure cuscino LxP	Adatto a seduta LSxPS	Codice	<input type="checkbox"/> 43 x 45	43x45	HS1717C	<input type="checkbox"/> 43 x 47,5	43x48	HS1718C	<input type="checkbox"/> 43 x 52,5	43x53	HS1720C	<input type="checkbox"/> 45,5 x 42,5	46x43	HS1816C	<input type="checkbox"/> 45,5 x 45	46x45	HS1817C	<input type="checkbox"/> 45,5 x 47,5	46x48	HS1818C	<input type="checkbox"/> 45,5 x 52,5	46x53	HS1820C	<input type="checkbox"/> 51 x 42,5	51x43	HS2016C	<input type="checkbox"/> 51 x 45	51x45	HS2017C	<input type="checkbox"/> 51 x 47,5	51x48	HS2018C	<input type="checkbox"/> 51 x 52,5	51x53	HS2020C		
Misure cuscino LxP	Adatto a seduta LSxPS	Codice																																																																									
<input type="checkbox"/> 35,5 x 37,5	36x38	HS1414C																																																																									
<input type="checkbox"/> 35,5 x 42,5	36x43	HS1416C																																																																									
<input type="checkbox"/> 38 x 40	38x40	HS1515C																																																																									
<input type="checkbox"/> 38 x 42,5	38x43	HS1516C																																																																									
<input type="checkbox"/> 38 x 45	38x45	HS1517C																																																																									
<input type="checkbox"/> 40,5 x 40	41x40	HS1615C																																																																									
<input type="checkbox"/> 40,5 x 42,5	41x43	HS1616C																																																																									
<input type="checkbox"/> 40,5 x 45	41x45	HS1617C																																																																									
<input type="checkbox"/> 40,5 x 47,5	41x48	HS1618C																																																																									
<input type="checkbox"/> 40,5 x 52,5	41x53	HS1620C																																																																									
<input type="checkbox"/> 43 x 42,5	43x43	HS1716C																																																																									
Misure cuscino LxP	Adatto a seduta LSxPS	Codice																																																																									
<input type="checkbox"/> 43 x 45	43x45	HS1717C																																																																									
<input type="checkbox"/> 43 x 47,5	43x48	HS1718C																																																																									
<input type="checkbox"/> 43 x 52,5	43x53	HS1720C																																																																									
<input type="checkbox"/> 45,5 x 42,5	46x43	HS1816C																																																																									
<input type="checkbox"/> 45,5 x 45	46x45	HS1817C																																																																									
<input type="checkbox"/> 45,5 x 47,5	46x48	HS1818C																																																																									
<input type="checkbox"/> 45,5 x 52,5	46x53	HS1820C																																																																									
<input type="checkbox"/> 51 x 42,5	51x43	HS2016C																																																																									
<input type="checkbox"/> 51 x 45	51x45	HS2017C																																																																									
<input type="checkbox"/> 51 x 47,5	51x48	HS2018C																																																																									
<input type="checkbox"/> 51 x 52,5	51x53	HS2020C																																																																									
ROHO® MONOCOMPARTIMENT® High Profile® altezza 10 cm 350,00																																																																											
<table border="1"> <thead> <tr> <th>Misure cuscino LxP</th> <th>Adatto a seduta LSxPS</th> <th>Codice</th> </tr> </thead> <tbody> <tr><td><input type="checkbox"/> 30 x 30 - (6 x 6)</td><td>26,5+31 x 26,5+31</td><td>1R66C</td></tr> <tr><td><input type="checkbox"/> 30 x 33 - (6 x 7)</td><td>26,5+31 x 31+35</td><td>1R67C</td></tr> <tr><td><input type="checkbox"/> 33 x 33 - (7 x 7)</td><td>31+35 x 31+35</td><td>1R77C</td></tr> <tr><td><input type="checkbox"/> 33 x 38 - (7 x 8)</td><td>31+35 x 35+39,5</td><td>1R78C</td></tr> <tr><td><input type="checkbox"/> 33 x 42 - (7 x 9)</td><td>31+35 x 39,5+44</td><td>1R79C</td></tr> <tr><td><input type="checkbox"/> 38 x 33 - (8 x 7)</td><td>35+39,5 x 31+35</td><td>1R87C</td></tr> <tr><td><input type="checkbox"/> 38 x 38 - (8 x 8)</td><td>35+39,5 x 35+39,5</td><td>1R88C</td></tr> <tr><td><input type="checkbox"/> 38 x 42 - (8 x 9)</td><td>35+39,5 x 39,5+44</td><td>1R89C</td></tr> <tr><td><input type="checkbox"/> 38 x 46 - (8 x 10)</td><td>35+39,5 x 44+48,5</td><td>1R810C</td></tr> <tr><td><input type="checkbox"/> 42 x 38 - (9 x 8)</td><td>39,5+44 x 35+39,5</td><td>1R98C</td></tr> <tr><td><input type="checkbox"/> 42 x 42 - (9 x 9)</td><td>39,5+44 x 39,5+44</td><td>1R99C</td></tr> </tbody> </table>	Misure cuscino LxP	Adatto a seduta LSxPS	Codice	<input type="checkbox"/> 30 x 30 - (6 x 6)	26,5+31 x 26,5+31	1R66C	<input type="checkbox"/> 30 x 33 - (6 x 7)	26,5+31 x 31+35	1R67C	<input type="checkbox"/> 33 x 33 - (7 x 7)	31+35 x 31+35	1R77C	<input type="checkbox"/> 33 x 38 - (7 x 8)	31+35 x 35+39,5	1R78C	<input type="checkbox"/> 33 x 42 - (7 x 9)	31+35 x 39,5+44	1R79C	<input type="checkbox"/> 38 x 33 - (8 x 7)	35+39,5 x 31+35	1R87C	<input type="checkbox"/> 38 x 38 - (8 x 8)	35+39,5 x 35+39,5	1R88C	<input type="checkbox"/> 38 x 42 - (8 x 9)	35+39,5 x 39,5+44	1R89C	<input type="checkbox"/> 38 x 46 - (8 x 10)	35+39,5 x 44+48,5	1R810C	<input type="checkbox"/> 42 x 38 - (9 x 8)	39,5+44 x 35+39,5	1R98C	<input type="checkbox"/> 42 x 42 - (9 x 9)	39,5+44 x 39,5+44	1R99C	<table border="1"> <thead> <tr> <th>Misure cuscino LxP</th> <th>Adatto a seduta LSxPS</th> <th>Codice</th> </tr> </thead> <tbody> <tr><td><input type="checkbox"/> 42 x 46 - (9 x 10)</td><td>39,5+44 x 44+48,5</td><td>1R910C</td></tr> <tr><td><input type="checkbox"/> 42 x 51 - (9 x 11)</td><td>39,5+44 x 48,5+52,5</td><td>1R911C</td></tr> <tr><td><input type="checkbox"/> 46 x 38 - (10 x 8)</td><td>44+48,5 x 35+39,5</td><td>1R108C</td></tr> <tr><td><input type="checkbox"/> 46 x 42 - (10 x 9)</td><td>44+48,5 x 39,5+44</td><td>1R109C</td></tr> <tr><td><input type="checkbox"/> 46 x 46 - (10 x 10)</td><td>44+48,5 x 44+48,5</td><td>1R1010C</td></tr> <tr><td><input type="checkbox"/> 46 x 51 - (10 x 11)</td><td>44+48,5 x 48,5+52,5</td><td>1R1011C</td></tr> <tr><td><input type="checkbox"/> 46 x 56 - (10 x 12)</td><td>44+48,5 x 52,5+57</td><td>1R1012C</td></tr> <tr><td><input type="checkbox"/> 51 x 42 - (11 x 9)</td><td>48,5+52,5 x 39,5+44</td><td>1R119C</td></tr> <tr><td><input type="checkbox"/> 51 x 46 - (11 x 10)</td><td>48,5+52,5 x 44+48,5</td><td>1R1110C</td></tr> <tr><td><input type="checkbox"/> 51 x 51 - (11 x 11)</td><td>48,5+52,5 x 48,5+52,5</td><td>1R1111C</td></tr> <tr><td><input type="checkbox"/> 51 x 56 - (11 x 12)</td><td>48,5+52,5 x 52,5+57</td><td>1R1112C</td></tr> </tbody> </table>	Misure cuscino LxP	Adatto a seduta LSxPS	Codice	<input type="checkbox"/> 42 x 46 - (9 x 10)	39,5+44 x 44+48,5	1R910C	<input type="checkbox"/> 42 x 51 - (9 x 11)	39,5+44 x 48,5+52,5	1R911C	<input type="checkbox"/> 46 x 38 - (10 x 8)	44+48,5 x 35+39,5	1R108C	<input type="checkbox"/> 46 x 42 - (10 x 9)	44+48,5 x 39,5+44	1R109C	<input type="checkbox"/> 46 x 46 - (10 x 10)	44+48,5 x 44+48,5	1R1010C	<input type="checkbox"/> 46 x 51 - (10 x 11)	44+48,5 x 48,5+52,5	1R1011C	<input type="checkbox"/> 46 x 56 - (10 x 12)	44+48,5 x 52,5+57	1R1012C	<input type="checkbox"/> 51 x 42 - (11 x 9)	48,5+52,5 x 39,5+44	1R119C	<input type="checkbox"/> 51 x 46 - (11 x 10)	48,5+52,5 x 44+48,5	1R1110C	<input type="checkbox"/> 51 x 51 - (11 x 11)	48,5+52,5 x 48,5+52,5	1R1111C	<input type="checkbox"/> 51 x 56 - (11 x 12)	48,5+52,5 x 52,5+57	1R1112C		
Misure cuscino LxP	Adatto a seduta LSxPS	Codice																																																																									
<input type="checkbox"/> 30 x 30 - (6 x 6)	26,5+31 x 26,5+31	1R66C																																																																									
<input type="checkbox"/> 30 x 33 - (6 x 7)	26,5+31 x 31+35	1R67C																																																																									
<input type="checkbox"/> 33 x 33 - (7 x 7)	31+35 x 31+35	1R77C																																																																									
<input type="checkbox"/> 33 x 38 - (7 x 8)	31+35 x 35+39,5	1R78C																																																																									
<input type="checkbox"/> 33 x 42 - (7 x 9)	31+35 x 39,5+44	1R79C																																																																									
<input type="checkbox"/> 38 x 33 - (8 x 7)	35+39,5 x 31+35	1R87C																																																																									
<input type="checkbox"/> 38 x 38 - (8 x 8)	35+39,5 x 35+39,5	1R88C																																																																									
<input type="checkbox"/> 38 x 42 - (8 x 9)	35+39,5 x 39,5+44	1R89C																																																																									
<input type="checkbox"/> 38 x 46 - (8 x 10)	35+39,5 x 44+48,5	1R810C																																																																									
<input type="checkbox"/> 42 x 38 - (9 x 8)	39,5+44 x 35+39,5	1R98C																																																																									
<input type="checkbox"/> 42 x 42 - (9 x 9)	39,5+44 x 39,5+44	1R99C																																																																									
Misure cuscino LxP	Adatto a seduta LSxPS	Codice																																																																									
<input type="checkbox"/> 42 x 46 - (9 x 10)	39,5+44 x 44+48,5	1R910C																																																																									
<input type="checkbox"/> 42 x 51 - (9 x 11)	39,5+44 x 48,5+52,5	1R911C																																																																									
<input type="checkbox"/> 46 x 38 - (10 x 8)	44+48,5 x 35+39,5	1R108C																																																																									
<input type="checkbox"/> 46 x 42 - (10 x 9)	44+48,5 x 39,5+44	1R109C																																																																									
<input type="checkbox"/> 46 x 46 - (10 x 10)	44+48,5 x 44+48,5	1R1010C																																																																									
<input type="checkbox"/> 46 x 51 - (10 x 11)	44+48,5 x 48,5+52,5	1R1011C																																																																									
<input type="checkbox"/> 46 x 56 - (10 x 12)	44+48,5 x 52,5+57	1R1012C																																																																									
<input type="checkbox"/> 51 x 42 - (11 x 9)	48,5+52,5 x 39,5+44	1R119C																																																																									
<input type="checkbox"/> 51 x 46 - (11 x 10)	48,5+52,5 x 44+48,5	1R1110C																																																																									
<input type="checkbox"/> 51 x 51 - (11 x 11)	48,5+52,5 x 48,5+52,5	1R1111C																																																																									
<input type="checkbox"/> 51 x 56 - (11 x 12)	48,5+52,5 x 52,5+57	1R1112C																																																																									

Data	Commessa	Utilizzatore	Indirizzo
------	----------	--------------	-----------

O ROHO® MONOCOMPARTIMENT® Low Profile® altezza 5 cm						350,00
<i>Misure cuscino</i> LxP	<i>Adatto a seduta</i> LSxPS	Codice	<i>Misure cuscino</i> LxP	<i>Adatto a seduta</i> LSxPS	Codice	
<input type="checkbox"/> 30 x 30 - (6 x 6)	26,5+31 x 26,5+31	1R66LPC	<input type="checkbox"/> 42 x 42 - (9 x 9)	39,5+44 x 39,5+44	1R99LPC	
<input type="checkbox"/> 30 x 33 - (6 x 7)	26,5+31 x 31+35	1R67LPC	<input type="checkbox"/> 42 x 46 - (9 x 10)	39,5+44 x 44+48,5	1R910LPC	
<input type="checkbox"/> 33 x 33 - (7 x 7)	31+35 x 31+35	1R77LPC	<input type="checkbox"/> 42 x 51 - (9 x 11)	39,5+44 x 48,5+52,5	1R911LPC	
<input type="checkbox"/> 33 x 38 - (7 x 8)	31+35 x 35+39,5	1R78LPC	<input type="checkbox"/> 46 x 38 - (10 x 8)	44+48,5 x 35+39,5	1R108LPC	
<input type="checkbox"/> 33 x 42 - (7 x 9)	31+35 x 39,5+44	1R79LPC	<input type="checkbox"/> 46 x 42 - (10 x 9)	44+48,5 x 39,5+44	1R109LPC	
<input type="checkbox"/> 38 x 33 - (8 x 7)	35+39,5 x 31+35	1R87LPC	<input type="checkbox"/> 46 x 46 - (10 x 10)	44+48,5 x 44+48,5	1R1010LPC	
<input type="checkbox"/> 38 x 38 - (8 x 8)	35+39,5 x 35+39,5	1R88LPC	<input type="checkbox"/> 46 x 51 - (10 x 11)	44+48,5 x 48,5+52,5	1R1011LPC	
<input type="checkbox"/> 38 x 42 - (8 x 9)	35+39,5 x 39,5+44	1R89LPC	<input type="checkbox"/> 51 x 42 - (11 x 9)	48,5+52,5 x 39,5+44	1R119LPC	
<input type="checkbox"/> 38 x 46 - (8 x 10)	35+39,5 x 44+48,5	1R810LPC	<input type="checkbox"/> 51 x 46 - (11 x 10)	48,5+52,5 x 44+48,5	1R1110LPC	
<input type="checkbox"/> 42 x 38 - (9 x 8)	39,5+44 x 35+39,5	1R98LPC	<input type="checkbox"/> 51 x 51 - (11 x 11)	48,5+52,5 x 48,5+52,5	1R1111LPC	

O ROHO® QUADTRO SELECT® High Profile® altezza 10 cm						630,00
<i>Misure cuscino</i> LxP	<i>Adatto a seduta</i> LSxPS	Codice	<i>Misure cuscino</i> LxP	<i>Adatto a seduta</i> LSxPS	Codice	
<input type="checkbox"/> 30 x 30 - (6 x 6)	26,5+31 x 26,5+31	QS66C	<input type="checkbox"/> 42 x 46 - (9 x 10)	39,5+44 x 44+48,5	QS910C	
<input type="checkbox"/> 30 x 33 - (6 x 7)	26,5+31 x 31+35	QS67C	<input type="checkbox"/> 42 x 51 - (9 x 11)	39,5+44 x 48,5+52,5	QS911C	
<input type="checkbox"/> 33 x 33 - (7 x 7)	31+35 x 31+35	QS77C	<input type="checkbox"/> 42 x 56 - (9 x 12)	39,5+44 x 52,5+57	QS912C	
<input type="checkbox"/> 33 x 38 - (7 x 8)	31+35 x 35+39,5	QS78C	<input type="checkbox"/> 46 x 38 - (10 x 8)	44+48,5 x 35+39,5	QS108C	
<input type="checkbox"/> 33 x 42 - (7 x 9)	31+35 x 39,5+44	QS79C	<input type="checkbox"/> 46 x 42 - (10 x 9)	44+48,5 x 39,5+44	QS109C	
<input type="checkbox"/> 38 x 33 - (8 x 7)	35+39,5 x 31+35	QS87C	<input type="checkbox"/> 46 x 46 - (10 x 10)	44+48,5 x 44+48,5	QS1010C	
<input type="checkbox"/> 38 x 38 - (8 x 8)	35+39,5 x 35+39,5	QS88C	<input type="checkbox"/> 46 x 51 - (10 x 11)	44+48,5 x 48,5+52,5	QS1011C	
<input type="checkbox"/> 38 x 42 - (8 x 9)	35+39,5 x 39,5+44	QS89C	<input type="checkbox"/> 46 x 56 - (10 x 12)	44+48,5 x 52,5+57	QS1012C	
<input type="checkbox"/> 38 x 46 - (8 x 10)	35+39,5 x 44+48,5	QS810C	<input type="checkbox"/> 51 x 42 - (11 x 9)	48,5+52,5 x 39,5+44	QS119C	
<input type="checkbox"/> 42 x 38 - (9 x 8)	39,5+44 x 35+39,5	QS98C	<input type="checkbox"/> 51 x 46 - (11 x 10)	48,5+52,5 x 44+48,5	QS1110C	
<input type="checkbox"/> 42 x 42 - (9 x 9)	39,5+44 x 39,5+44	QS99C	<input type="checkbox"/> 51 x 51 - (11 x 11)	48,5+52,5 x 48,5+52,5	QS1111C	

O ROHO® QUADTRO SELECT® Low Profile® altezza 5 cm						630,00
<i>Misure cuscino</i> LxP	<i>Adatto a seduta</i> LSxPS	Codice	<i>Misure cuscino</i> LxP	<i>Adatto a seduta</i> LSxPS	Codice	
<input type="checkbox"/> 28 x 30 - (5 x 6)	22+26,5 x 26,5+31	QS56LPC	<input type="checkbox"/> 42 x 42 - (9 x 9)	39,5+44 x 39,5+44	QS99LPC	
<input type="checkbox"/> 30 x 30 - (6 x 6)	26,5+31 x 26,5+31	QS66LPC	<input type="checkbox"/> 42 x 46 - (9 x 10)	39,5+44 x 44+48,5	QS910LPC	
<input type="checkbox"/> 30 x 33 - (6 x 7)	26,5+31 x 31+35	QS67LPC	<input type="checkbox"/> 42 x 51 - (9 x 11)	39,5+44 x 48,5+52,5	QS911LPC	
<input type="checkbox"/> 33 x 33 - (7 x 7)	31+35 x 31+35	QS77LPC	<input type="checkbox"/> 46 x 38 - (10 x 8)	44+48,5 x 35+39,5	QS108LPC	
<input type="checkbox"/> 33 x 38 - (7 x 8)	31+35 x 35+39,5	QS78LPC	<input type="checkbox"/> 46 x 42 - (10 x 9)	44+48,5 x 39,5+44	QS109LPC	
<input type="checkbox"/> 33 x 42 - (7 x 9)	31+35 x 39,5+44	QS79LPC	<input type="checkbox"/> 46 x 46 - (10 x 10)	44+48,5 x 44+48,5	QS1010LPC	
<input type="checkbox"/> 38 x 33 - (8 x 7)	35+39,5 x 31+35	QS87LPC	<input type="checkbox"/> 46 x 51 - (10 x 11)	44+48,5 x 48,5+52,5	QS1011LPC	
<input type="checkbox"/> 38 x 38 - (8 x 8)	35+39,5 x 35+39,5	QS88LPC	<input type="checkbox"/> 51 x 42 - (11 x 9)	48,5+52,5 x 39,5+44	QS119LPC	
<input type="checkbox"/> 38 x 42 - (8 x 9)	35+39,5 x 39,5+44	QS89LPC	<input type="checkbox"/> 51 x 46 - (11 x 10)	48,5+52,5 x 44+48,5	QS1110LPC	
<input type="checkbox"/> 38 x 46 - (8 x 10)	35+39,5 x 44+48,5	QS810LPC	<input type="checkbox"/> 51 x 51 - (11 x 11)	48,5+52,5 x 48,5+52,5	QS1111LPC	
<input type="checkbox"/> 42 x 38 - (9 x 8)	39,5+44 x 35+39,5	QS98LPC				

O ROHO® CONTOUR SELECT®						630,00
<i>Misure cuscino</i> LxP	<i>Adatto a seduta</i> LSxPS	Codice	<i>Misure cuscino</i> LxP	<i>Adatto a seduta</i> LSxPS	Codice	
<input type="checkbox"/> 33 x 38 - (7 x 8)	31+35 x 35+39,5	CS78C	<input type="checkbox"/> 42 x 51 - (9 x 11)	39,5+44 x 48,5+52,5	CS911C	
<input type="checkbox"/> 38 x 38 - (8 x 8)	35+39,5 x 35+39,5	CS88C	<input type="checkbox"/> 46 x 42 - (10 x 9)	44+48,5 x 39,5+44	CS109C	
<input type="checkbox"/> 38 x 42 - (8 x 9)	35+39,5 x 39,5+44	CS89C	<input type="checkbox"/> 46 x 46 - (10 x 10)	44+48,5 x 44+48,5	CS1010C	
<input type="checkbox"/> 38 x 46 - (8 x 10)	35+39,5 x 44+48,5	CS810C	<input type="checkbox"/> 46 x 51 - (10 x 11)	44+48,5 x 48,5+52,5	CS1011C	
<input type="checkbox"/> 42 x 38 - (9 x 8)	39,5+44 x 35+39,5	CS98C	<input type="checkbox"/> 51 x 42 - (11 x 9)	48,5+52,5 x 39,5+44	CS119C	
<input type="checkbox"/> 42 x 42 - (9 x 9)	39,5+44 x 39,5+44	CS99C	<input type="checkbox"/> 51 x 46 - (11 x 10)	48,5+52,5 x 44+48,5	CS1110C	
<input type="checkbox"/> 42 x 46 - (9 x 10)	39,5+44 x 44+48,5	CS910C	<input type="checkbox"/> 51 x 51 - (11 x 11)	48,5+52,5 x 48,5+52,5	CS1111C	

O ROHO® ENHANCER®						630,00
<i>Misure cuscino</i> LxP	<i>Adatto a seduta</i> LSxPS	Codice	<i>Misure cuscino</i> LxP	<i>Adatto a seduta</i> LSxPS	Codice	
<input type="checkbox"/> 38 x 38 - (8 x 8)	35+39,5 x 35+39,5	ENH88C	<input type="checkbox"/> 46 x 42 - (10 x 9)	44+48,5 x 39,5+44	ENH109C	
<input type="checkbox"/> 38 x 42 - (8 x 9)	35+39,5 x 39,5+44	ENH89C	<input type="checkbox"/> 46 x 46 - (10 x 10)	44+48,5 x 44+48,5	ENH1010C	
<input type="checkbox"/> 42 x 38 - (9 x 8)	39,5+44 x 35+39,5	ENH98C	<input type="checkbox"/> 46 x 51 - (10 x 11)	44+48,5 x 48,5+52,5	ENH1011C	
<input type="checkbox"/> 42 x 42 - (9 x 9)	39,5+44 x 39,5+44	ENH99C	<input type="checkbox"/> 51 x 46 - (11 x 10)	48,5+52,5 x 44+48,5	ENH1110C	
<input type="checkbox"/> 42 x 46 - (9 x 10)	39,5+44 x 44+48,5	ENH910C				

Carrozina : Progeo TEKNA TILT 2.0 - Rev. 2024.1	Prezzo IVA esclusa da sommare al prezzo di listino	Pagina da inviare se sono stati scelti optional <input checked="" type="checkbox"/> standard (fornito in assenza di altre indicazioni) <input type="checkbox"/> su richiesta (senza aggiunta di prezzo) <input type="checkbox"/> optional (sommare il prezzo a quello di listino)
--	--	---

Rehaleam s.r.l. - Vicolo Negrelli, 5 - 31038 Castagnole di Paese (TV) - Tel. +39 0422 484657/+39 0422 480367 - Fax +39 0422 484661/+39 0422 484684 - P.IVA IT 03182520266 - C.C.I.A.A. TV n.225867 - iscr.Trib. TV n.41690 Capitale Sociale I.V. Euro 100.000,00
 la società è soggetta ex art. 2497-bis C.C. al coordinamento e direzione della società "PERMOBIL ITALY SRL" iscritta al Registro Imprese Milano Monza Brianza Lodi 10246110968

Email: info_it@permobil.com - web: http://www.rehaleamprogeo.com

Rehateam s.r.l. - Viale Negrelli, 5 - 31038 Castagnole di Paese (TV) - Tel. +39.0422.484657/+39.0422.480387 - Fax +39.0422.484661/+39.0422.484684 - P.IVA IT 03182520266 - C.C.I.A.A. TV n. 225867 - Iscr. Trib. TV n. 41690 Capitale Sociale I.V. Euro 100.000,00 la società è soggetta ex art. 2497-bis C.C. al coordinamento e direzione della società "PERMOBIL ITALY SRL" iscritta al Registro Imprese Milano Monza Brianza Lodi 10246110988

Data	Commessa	Utilizzatore	Indirizzo
------------	----------------	--------------------	-----------------

SMARTDRIVE



SMARTDRIVE MX2 - 6KM/H
compreso di caricabatteria

SMARTDRIVE MX2 - 9KM/H
compreso di caricabatteria

<input type="radio"/> SWITCH CONTROL (DX+SX) - EU	MX2-S002	4.000,00
<input type="radio"/> SWITCH CONTROL + JACK 3.5 - EU	MX2-S003	4.000,00
<input type="radio"/> SPEED CONTROL DIAL - EU	MX2-S001	4.250,00
<input type="radio"/> SWITCH CONTROL (DX+SX) - EU	MX2-S005	4.100,00
<input type="radio"/> SWITCH CONTROL + JACK 3.5 - EU	MX2-S006	4.100,00
<input type="radio"/> SPEED CONTROL DIAL - EU	MX2-S004	4.350,00

SWITCH CONTROL



SWITCH CONTROL + JACK (3,5 mono)



Ingresso femmina Mono, permette di collegare SmartDrive con un qualsiasi altro dispositivo di comando/guida.

SPEED CONTROL DIAL



Manopola di controllo graduale della velocità

KIT FISSAGGIO TELAIO PIEGHEVOLE

Scegliere kit di fissaggio in funzione della misura delle ruote posteriori della carrozina

<input type="checkbox"/> kit fissaggio telaio pieghevole - ruote posteriori 22" - 24"	MX2-443-C
<input type="checkbox"/> kit fissaggio telaio pieghevole - ruote posteriori 25"	MX2-453-C
<input type="checkbox"/> kit fissaggio telaio pieghevole - ruote posteriori 26"	MX2-463-C

SMART WATCH

Lo SmartDrive può essere comandato e gestito con uno Smart Watch APPLE o GALAXY
 Configurazione semplice e veloce
 Maggiore visibilità dello schermo
 Prestazioni della batteria migliorate
 App gratuita su Apple Store e Play Store

Lista compatibilità'



Smart Watch compatibili

APPLE WATCH
serie 5 o successivi con iOS 8 o successivi
Apple iPhone

GALAXY WATCH
serie 4 o successivi
Smartphone Samsung
Smartphone Android 6.0 e RAM almeno 1.5 GB

Applicazioni gratuite



SmartDrive MX2+



Pushtracker



Accessori

<input type="radio"/> Borsa da trasporto		MX2SD-BAG	60,00
<input type="radio"/> Maniglia universale imbottita <i>Maniglia universale imbottita</i>		MX2-986	20,00

Carrozina : Progeo TEKNA TILT 2.0 - Rev. 2024.1	Prezzo IVA esclusa da sommare al prezzo di listino	<p style="text-align: center; font-size: small;">Pagina da inviare se sono stati scelti optional</p> <table style="width: 100%; border-collapse: collapse;"> <tr> <td style="width: 10%;"><input checked="" type="checkbox"/></td> <td style="width: 60%;">standard</td> <td style="width: 30%; font-size: x-small;">(fornito in assenza di altre indicazioni)</td> </tr> <tr> <td><input type="checkbox"/></td> <td>su richiesta</td> <td>(senza aggiunta di prezzo)</td> </tr> <tr> <td><input type="checkbox"/></td> <td>optional</td> <td>(sommare il prezzo a quello di listino)</td> </tr> </table>	<input checked="" type="checkbox"/>	standard	(fornito in assenza di altre indicazioni)	<input type="checkbox"/>	su richiesta	(senza aggiunta di prezzo)	<input type="checkbox"/>	optional	(sommare il prezzo a quello di listino)
<input checked="" type="checkbox"/>	standard	(fornito in assenza di altre indicazioni)									
<input type="checkbox"/>	su richiesta	(senza aggiunta di prezzo)									
<input type="checkbox"/>	optional	(sommare il prezzo a quello di listino)									

Email: info_it@permobil.com - web: http://www.rehateamprogeo.com